

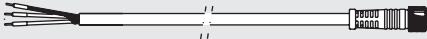

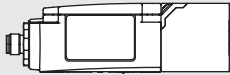



Selection table for non-contact safety switches CES-A-C.../CES-A-W.../CES-A-S...

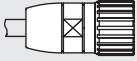
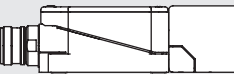

Connection cable/mating connector	Safety switch	Actuator	Bolts
 <p>Page 87</p>	 <p>CES-A-C5... CES-A-W5... Page 80</p>	<p>CES-A-BBA  Page 84</p> <p>CES-A-BCA  Page 84</p> <p>CES-A-BPA  Page 85</p>	Page 159/160
 <p>Page 88</p>	 <p>CES-A-S5... Page 82</p>	<p>Same safety actuator as for CES-A-C5.../CES-A-W5... possible.</p> <p>Position actuator CES-A-NBA  Page 86</p>	-

Possible combinations for CES components

To give you a quick overview of which CES components can be combined with each other, there is a combinations table for each evaluation unit and for each safety switch. The table will answer the following questions:

- ▶ Which read head is allowed to be connected to the related safety switch?
- ▶ What is the operating distance of this combination?
- ▶ Which type of guard locking can be realized with the selected combination?

Important: Only typical values are listed in the table. The minimum and maximum values are listed in the technical data for the related product.

Key to symbols	15	Combination possible, typ. switch-on distance 15 mm
		Combination possible, guard locking for process protection
		Combination possible, guard locking for personal protection
		Combination not permissible

Non-contact safety switches CES-A-.5

Safety switch	Actuator				
	CES-A-BBA-EX 098 158	CES-A-BBA 071 840	CES-A-BCA 088 786	CES-A-NBA... All items	CES-A-BPA 098 775
CES-A-C5E-01 077 750		20	20		30
CES-A-C5H-01 091 458		20	20		30
CES-A-C5H-01-EX 097 945	20				
CES-A-W5H-01 097 525		20	20		30
CES-A-S5H-01 090 640		20	20	20	30

Non-contact safety switches CES-A-C5... / CES-A-W5...



Cat. 3/4
PLe

- ▶ Read head with integrated evaluation electronics
- ▶ Switching of clocked signals possible
- ▶ 2 safety outputs (semiconductor outputs)
- ▶ Up to category 4 / PL e according to EN ISO 13849-1



For possible combinations see page 79

Approach direction

Can be adjusted in 90° steps

Unicode evaluation

Each actuator is unique. The evaluation unit detects only the actuator that has been taught-in. Additional actuators can be taught-in.

Multicode evaluation

Every actuator is detected by the evaluation unit

Category according to EN ISO 13849-1

Due to two redundant design semiconductor outputs (safety outputs) with internal monitoring suitable for:

- ▶ CES-A-C5E-01, category 3 / PL e according to EN ISO 13849-1
- ▶ CES-A-C5H-01/CES-A-W5H-01, category 4 / PL e according to EN ISO 13849-1

LED display

STATE Status LED
OUT/ERROR Status safety output/
diagnostic LED (combined)

Additional connections

OUT Monitoring output (semiconductor)

Warning:

The operating distance may vary depending on the background material and installation situation.

Non-contact safety switches CES-A-C5... / CES-A-W5...

M12 plug, 8-pin

Dimension drawing

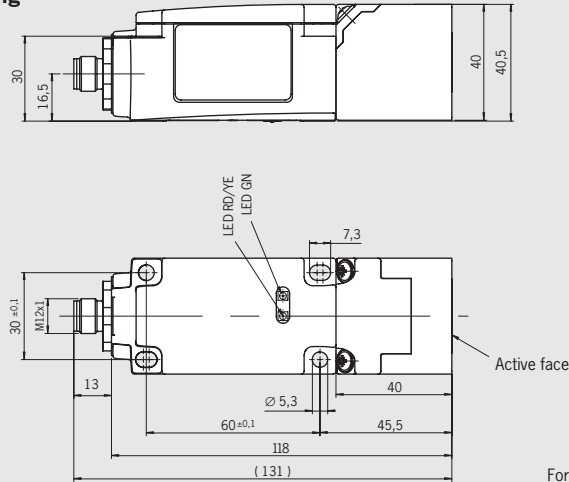

For connection cable see page 87

Block diagram

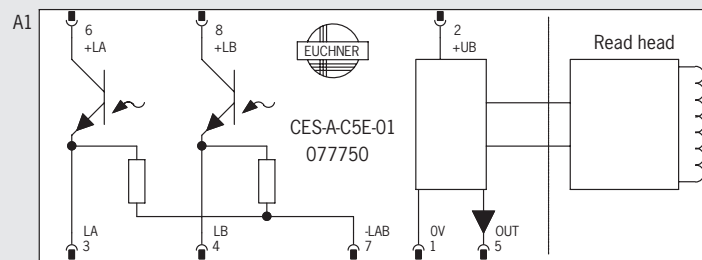

Pin assignment

- | | |
|---------|----------|
| 1 ▶ 0 V | 5 ▶ OUT |
| 2 ▶ +UB | 6 ▶ +LA |
| 3 ▶ LA | 7 ▶ -LAB |
| 4 ▶ LB | 8 ▶ +LB |

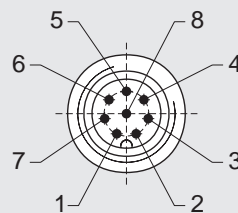

View on the connection side of the safety switch

The screen on the connection cable is connected internally to the safety switch screen bonding clamp via the knurled nut on the M12 plug connector.

Typical operating distance

(Only in combination with actuator CES-A-BBA)

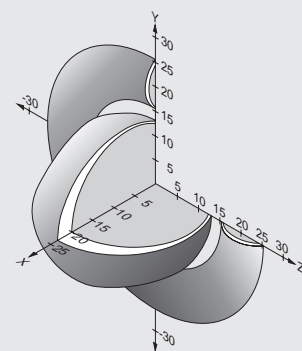

For a side approach direction for the actuator and safety switch, a minimum distance of $s = 3$ mm must be maintained so that the operating distance of the side lobes is not entered.

Ordering table

Series	Category and PL according to EN ISO 13849-1	Type	Order no. / item
CES-A-C5... Unicode	3 / PL e		077 750 CES-A-C5E-01
	4 / PL e		091 458 CES-A-C5H-01
	4 / PL e	ATEX ¹⁾	097 945 ¹⁾ CES-A-C5H-01-EX
CES-A-W5... Multicode	4 / PL e		097 525 CES-A-W5H-01

1) EX II 3 G Ex nA IIB T5 (zone 2, gases), EX II 3 D Ex tD A22 T90°C (zone 22, dusts)

Technical data non-contact safety switches CES-A-C5... / CES-A-W5...

Parameter	Value			Unit
	min.	typ.	max.	
Housing material	Plastic PBT V0 GF30			
Dimensions	According to EN 60947-5-2			mm
Weight	0.4			kg
Ambient temperature at $U_B = DC 24 V$	-20	-	+55	°C
Degree of protection	IP67			
Degree of contamination	3			
Installation position	Any			
Connection type	M12 plug connector, 8-pin, screen can be applied			
Operating voltage U_B (regulated, residual ripple < 5 %)	18	24	27	V DC
For the approval according to UL the following applies	Operation with UL-class 2 power supply only, or equivalent measures			
Current consumption	80			mA
Switching load according to UL	max. DC 24 V, class 2			
External fuse (operating voltage U_B)	0.25	-	8	A
Power supply for load $U(+LA)/U(+LB)$	18	-	27	V DC
Safety outputs (LA / LB, 2 semiconductor outputs, p-switching, short circuit-proof, electrically decoupled)				
- Output voltage $U(LA)/U(LB)$ ¹⁾				
HIGH $U(LA)$	$U(+LA) - 1.5$	-	$U(+LA)$	V DC
HIGH $U(LB)$	$U(+LB) - 1.5$	-	$U(+LB)$	
LOW $U(LA)/U(LB)$	0	-	1	
Switching current per safety output	1	-	400	mA
External fuse ($U(+LA)/U(+LB)$, safety circuit)	400 mA medium slow-blow			
Utilization category acc. to EN 60947-5-2	DC-13 24V 400mA			
Classification according to EN 60947-5-3	PDF-M			
Door monitoring output (OUT, semiconductor output, p-switching, short circuit-proof)				
- Output voltage	$0.8 \times U_B$	-	U_B	V DC
- Max. load	-	-	20	mA
Rated insulation voltage U_i	-	-	300 ²⁾	V
Rated impulse withstand voltage U_{imp}	-	-	1.5	kV
Rated conditional short-circuit current	100			A
Resilience to vibration	According to EN 60947-5-2			
Switching delay from state change ³⁾	-	-	180	ms
Difference time between the two safety outputs	-	-	120	ms
Ready delay ⁴⁾	-	-	3	s
Dwell time ⁵⁾	0.5	-	-	s
Switching frequency	-	-	1	Hz
Repeat accuracy R according to EN IEC 60947-5-3	≤ 10			%
Mounting distance between 2 switches or 2 actuators	80	-	-	mm
EMC protection requirements	In acc. with EN 60947-5-3			
In combination with actuator CES-A-BBA/CES-A-BCA				
Operating distance for center offset $m = 0$				
- Switch-on distance	-	20	-	mm
- Assured switch-on distance s_{so} ⁶⁾	18	-	-	
- Switching hysteresis ⁶⁾	2	3	-	
- Assured switch-off distance s_{sr}	-	-	40	
In combination with actuator CES-A-BPA				
Operating distance for center offset $m = 0$				
- Switch-on distance	-	22 ⁷⁾	-	mm
- Assured switch-on distance s_{so}	15	-	-	
- Switching hysteresis ⁶⁾	1	2	-	
- Assured switch-off distance s_{sr}	-	-	58	
LED displays	STATE OUT/ERROR OUT/ERROR	Green LED: flashing: Yellow LED: Red LED:	Normal operation Teach-in operation Actuator detected - EMC interference - Internal electronics fault - Invalid teach-in operation	
Reliability figures according to EN ISO 13849-1	CES-A-C5E-...	CES-A-C5H-.../CES-A-W5H-...		
Category	3	4		
Performance level (PL)	e	e		
PFH _d	$4.29 \times 10^{-8} / h$	$3.7 \times 10^{-9} / h$ ⁸⁾		
Mission time	20	20	years	

1) Values at a switching current of 50 mA without taking into account the cable lengths.

2) Tested by BG up to 75 V.

3) Corresponds to the risk time according to EN 60947-5-3. This is the maximum switch-off delay for the safety outputs following removal of the actuator.

4) After the operating voltage is switched on, the semiconductor outputs are switched off and the monitoring outputs are set LOW during the ready delay.

5) The dwell time of an actuator inside and outside the operating distance must be at least 0.5 s to ensure reliable detection of internal faults in the evaluation unit (self-monitoring).

6) Values apply for surface mounting of the actuator.

7) On surface mounting on aluminum, in a non-metallic environment the typical switching distance increases to 30 mm.

8) Applying the limit value from EN ISO 13849-1:2008, section 4.5.2 (MTTF_d = max. 100 years) BG certifies a PFH_d BG certifies a 2.47×10^{-8} .